

CONTROL ENCLOSURE

BURNER ENCLOSURE

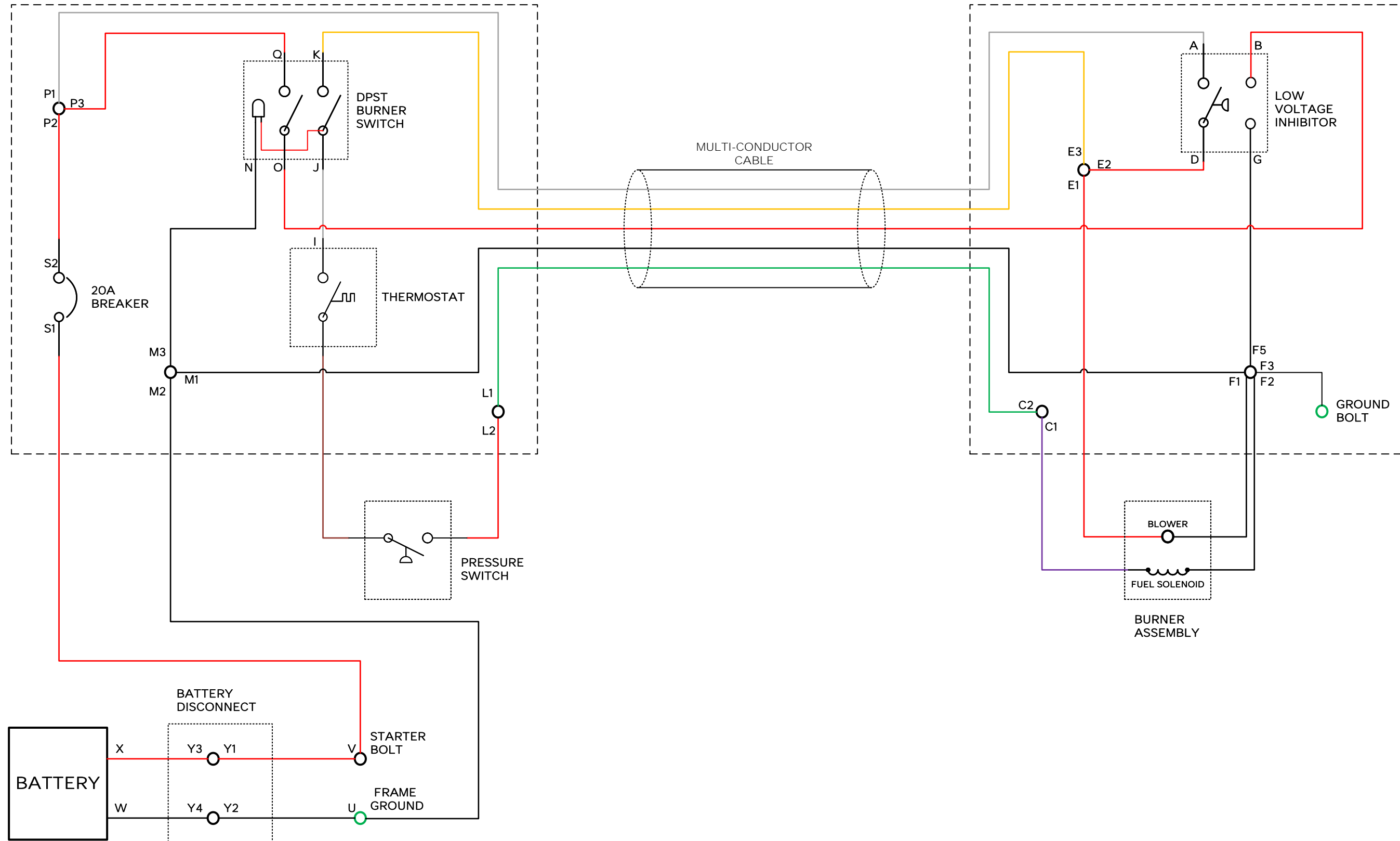

DRAWN: DATE:	Vincent Royer 2022-05-12	REVISION # DATE	6 2022-05-12	SHEET: MACHINE SCHEMATIC	SHEET 2 OF 4
PREPARED FOR: REVIEWED BY:	CM DN	LOCATION: PROJECT #:		PROJECT: HW4214VA WIRING HARNESS	BE POWER EQUIPMENT

